

IGBT High Speed

IXSH 50N60B

$V_{CES} = 600 \text{ V}$
 $I_{C25} = 75 \text{ A}$
 $V_{CE(sat)} = 2.5 \text{ V}$

Short Circuit SOA Capability

Preliminary data sheet

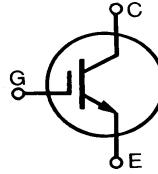

Symbol	Test Conditions	Maximum Ratings	
V_{CES}	$T_J = 25^\circ\text{C to } 150^\circ\text{C}$	600	V
V_{CGR}	$T_J = 25^\circ\text{C to } 150^\circ\text{C}; R_{GE} = 1 \text{ M}\Omega$	600	V
V_{GES}	Continuous	± 20	V
V_{GEM}	Transient	± 30	V
I_{C25}	$T_C = 25^\circ\text{C}$, limited by leads	75	A
I_{C90}	$T_C = 90^\circ\text{C}$	50	A
I_{CM}	$T_C = 25^\circ\text{C}$, 1 ms	200	A
SSOA (RBSOA)	$V_{GE} = 15 \text{ V}$, $T_{VJ} = 125^\circ\text{C}$, $R_G = 22 \Omega$ Clamped inductive load, $L = 30 \mu\text{H}$	$I_{CM} = 100$ @ $0.8 V_{CES}$	A
t_{SC} (SCSOA)	$V_{GE} = 15 \text{ V}$, $V_{CE} = 360 \text{ V}$, $T_J = 125^\circ\text{C}$ $R_G = 22 \Omega$, non repetitive	10	μs
P_c	$T_C = 25^\circ\text{C}$	250	W
T_J		-55 ... +150	$^\circ\text{C}$
T_{JM}		150	$^\circ\text{C}$
T_{stg}		-55 ... +150	$^\circ\text{C}$
M_d	Mounting torque	1.13/10	Nm/lb.in.
Weight		TO-247 SMD 4	g
		TO-247 6	g
Maximum lead temperature for soldering 1.6 mm (0.062 in.) from case for 10 s		300	$^\circ\text{C}$

TO-247 AD

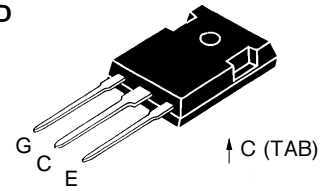

G = Gate, C = Collector,
E = Emitter, TAB = Collector

Features

- International standard package JEDEC TO-247 AD, and TO-247 SMD for surface mount
- Guaranteed Short Circuit SOA capability
- High frequency IGBT
- Latest generation HDMOS™ process
- Low $V_{CE(sat)}$
- for minimum on-state conduction losses
- MOS Gate turn-on
- drive simplicity

Applications

- AC motor speed control
- DC servo and robot drives
- DC choppers
- Uninterruptible power supplies (UPS)
- Switch-mode and resonant-mode power supplies

Advantages

- Easy to mount with 1 screw (isolated mounting screw hole)
- Reduces assembly time and cost
- High power density

Symbol	Test Conditions	Characteristic Values ($T_J = 25^\circ\text{C}$, unless otherwise specified)		
		min.	typ.	max.
BV_{CES}	$I_C = 250 \mu\text{A}$, $V_{GE} = 0 \text{ V}$	600		V
$V_{GE(th)}$	$I_C = 4 \text{ mA}$, $V_{CE} = V_{GE}$	4		V
I_{CES}	$V_{CE} = 0.8 \cdot V_{CES}$, $T_J = 25^\circ\text{C}$ $V_{GE} = 0 \text{ V}$, $T_J = 125^\circ\text{C}$			200 μA 1 mA
I_{GES}	$V_{CE} = 0 \text{ V}$, $V_{GE} = \pm 20 \text{ V}$			$\pm 100 \text{ nA}$
$V_{CE(sat)}$	$I_C = I_{C90}$, $V_{GE} = 15 \text{ V}$	2.2	2.5	V

Symbol	Test Conditions	Characteristic Values ($T_J = 25^\circ\text{C}$, unless otherwise specified)		
		min.	typ.	max.
g_{fs}	$I_C = I_{C90}$; $V_{CE} = 10\text{ V}$, Pulse test, $t \leq 300\ \mu\text{s}$, duty cycle $\leq 2\%$	16	23	S
$I_{C(on)}$	$V_{GE} = 15\text{ V}$, $V_{CE} = 10\text{ V}$		160	A
C_{ies}	$V_{CE} = 25\text{ V}$, $V_{GE} = 0\text{ V}$, $f = 1\text{ MHz}$		3850	pF
C_{oes}			440	pF
C_{res}			50	pF
Q_g	$I_C = I_{C90}$, $V_{GE} = 15\text{ V}$, $V_{CE} = 0.5 V_{CES}$		167	nC
Q_{ge}			45	nC
Q_{gc}			88	nC
$t_{d(on)}$	Inductive load, $T_J = 25^\circ\text{C}$		70	ns
t_{ri}	$I_C = I_{C90}$, $V_{GE} = 15\text{ V}$, $L = 100\ \mu\text{H}$, $V_{CE} = 0.8 V_{CES}$, $R_G = 2.7\ \Omega$		70	ns
$t_{d(off)}$			150	300 ns
t_{fi}	Remarks: Switching times may increase for V_{CE} (Clamp) $> 0.8 \cdot V_{CES}$, higher T_J or increased R_G		150	300 ns
E_{off}			3.3	6.0 mJ
$t_{d(on)}$	Inductive load, $T_J = 125^\circ\text{C}$		70	ns
t_{ri}	$I_C = I_{C90}$, $V_{GE} = 15\text{ V}$, $L = 100\ \mu\text{H}$, $V_{CE} = 0.8 V_{CES}$, $R_G = 2.7\ \Omega$		70	ns
E_{on}			0.6	mJ
$t_{d(off)}$	Remarks: Switching times may increase for V_{CE} (Clamp) $> 0.8 \cdot V_{CES}$, higher T_J or increased R_G		230	ns
t_{fi}			230	ns
E_{off}		4.8	mJ	
R_{thJC}				0.5 K/W
R_{thCK}		0.25		K/W

TO-247 AD Outline

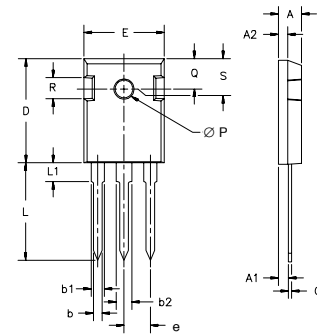

Dim.	Millimeter		Inches	
	Min.	Max.	Min.	Max.
A	4.7	5.3	.185	.209
A ₁	2.2	2.54	.087	.102
A ₂	2.2	2.6	.059	.098
b	1.0	1.4	.040	.055
b ₁	1.65	2.13	.065	.084
b ₂	2.87	3.12	.113	.123
C	.4	.8	.016	.031
D	20.80	21.46	.819	.845
E	15.75	16.26	.610	.640
e	5.20	5.72	0.205	0.225
L	19.81	20.32	.780	.800
L1		4.50		.177
ØP	3.55	3.65	.140	.144
Q	5.89	6.40	0.232	0.252
R	4.32	5.49	.170	.216
S	6.15	BSC	.242	BSC

IXYS reserves the right to change limits, test conditions, and dimensions.

IXYS MOSFETS and IGBTs are covered by one or more of the following U.S. patents: 4,835,592 4,881,106 5,017,508 5,049,961 5,187,117 5,486,715
4,850,072 4,931,844 5,034,796 5,063,307 5,237,481 5,381,025

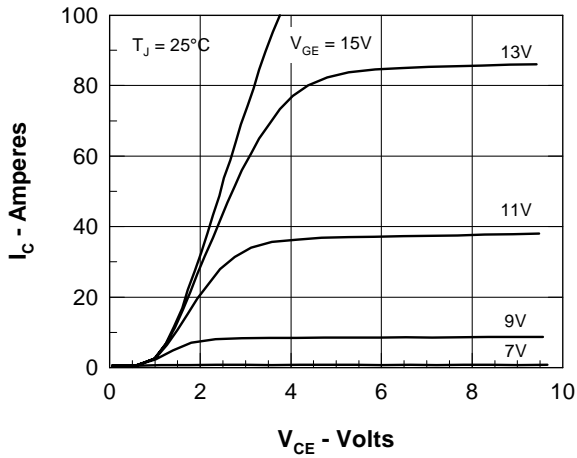

Figure 1. Saturation Voltage Characteristics

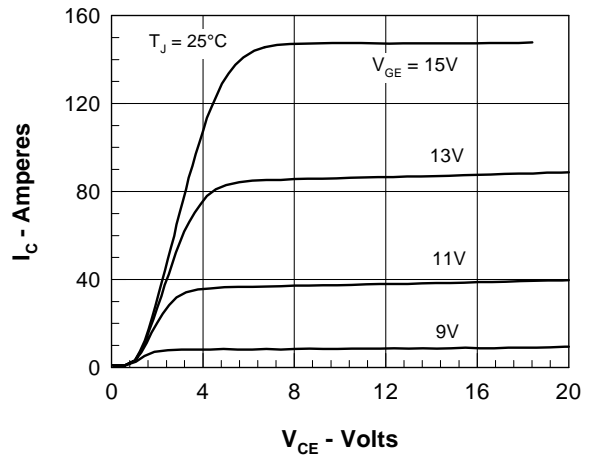

Figure 2. Extended Output Characteristics

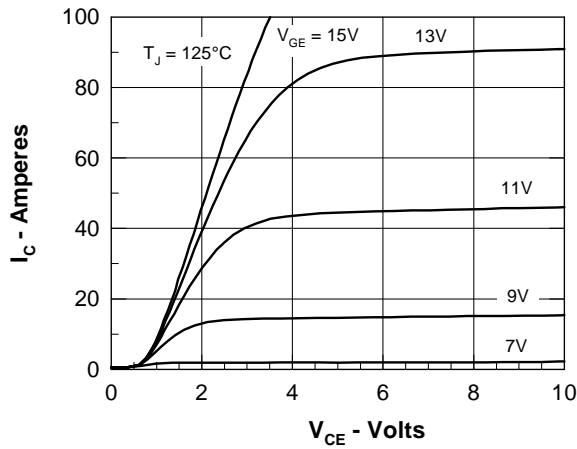

Figure 3. Saturation Voltage Characteristics

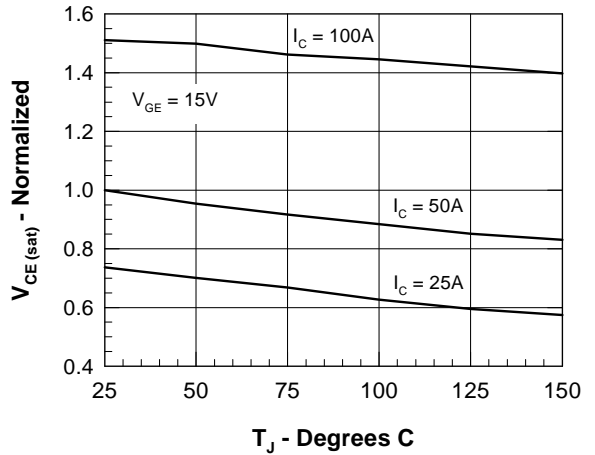
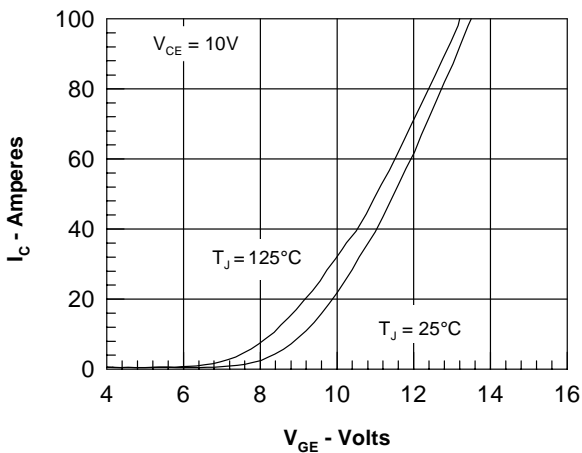

 Figure 4. Temperature Dependence of $V_{CE(sat)}$

Figure 5. Admittance Curves

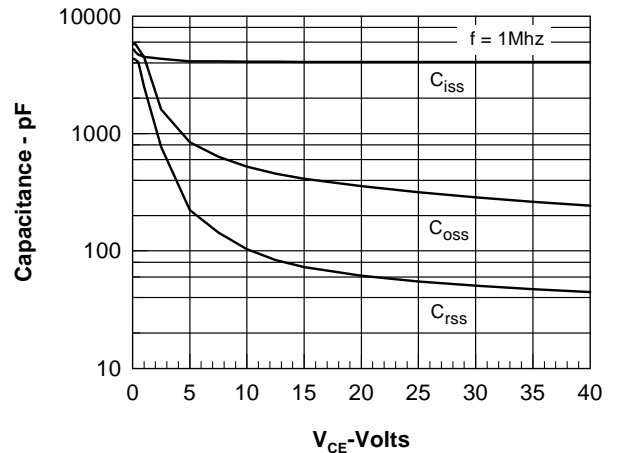

Figure 6. Capacitance Curves

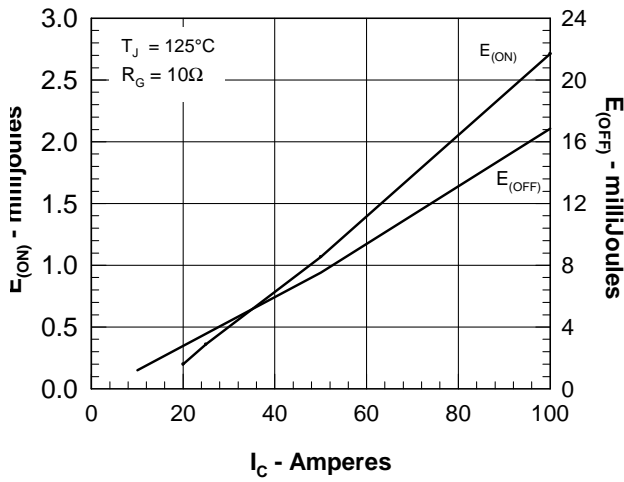

Figure 7. Dependence of E_{ON} and E_{OFF} on I_C .

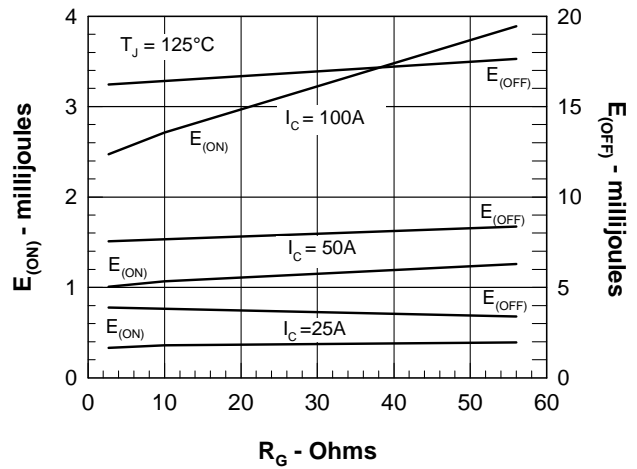

Figure 8. Dependence of E_{ON} and E_{OFF} on R_G .

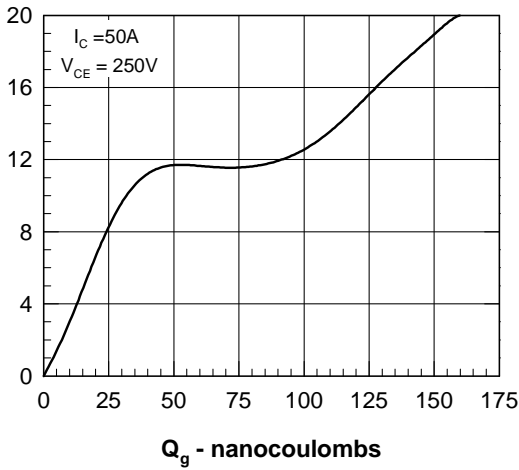

Figure 9. Gate Charge

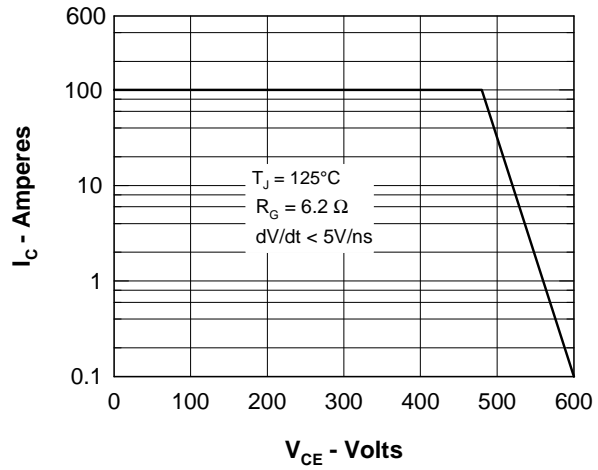

Figure 10. Turn-off Safe Operating Area

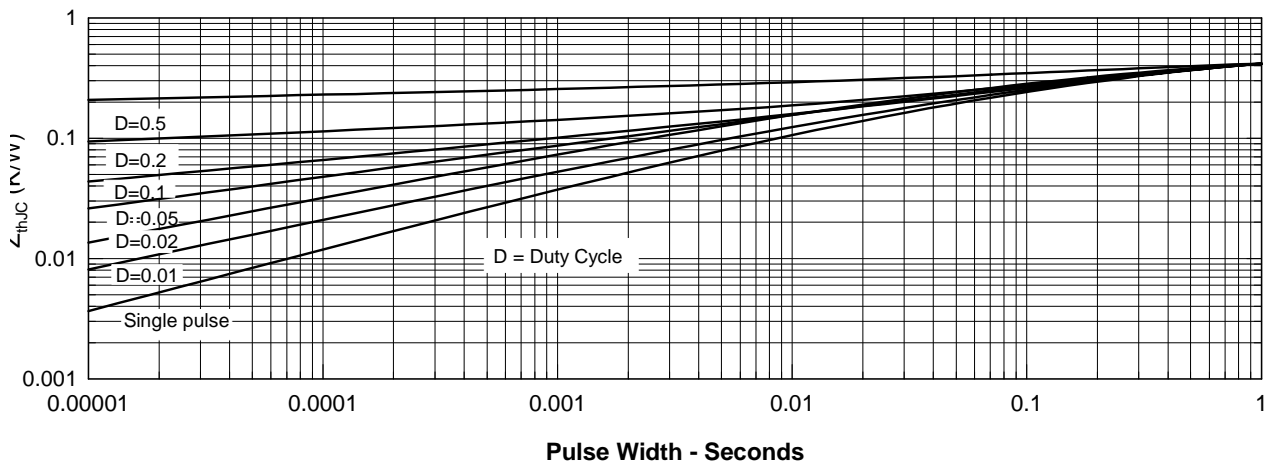

Figure 11. Transient Thermal Resistance

IXYS reserves the right to change limits, test conditions, and dimensions.

IXYS MOSFETs and IGBTs are covered by one or more of the following U.S. patents: 4,835,592 4,881,106 5,017,508 5,049,961 5,187,117 5,486,715
4,850,072 4,931,844 5,034,796 5,063,307 5,237,481 5,381,025